

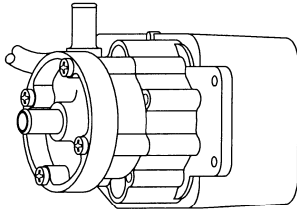

MARCH PUMPS

1819 PICKWICK AVE., GLENVIEW, IL 60026-1306, U.S.A
 PHONE: (847) 729-5300 - FAX: (847) 729-7062
 WWW.MARCHPUMP.COM

1A-MD, AC-1A-MD 1C-MD, AC-1C-MD 1U-MD



1A-MD-3/8

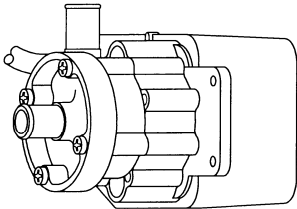

1A-MD-1/2

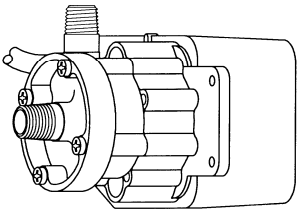

1C-MD

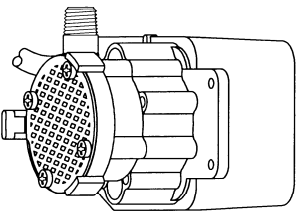

1U-MD

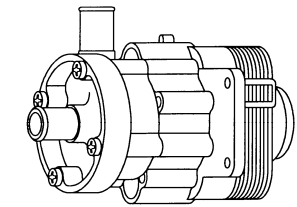

AC-1A-MD-1/2

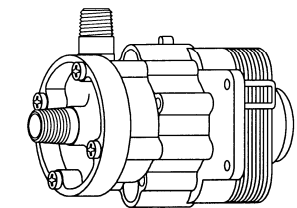

AC-1C-MD

MODEL ABBREVIATIONS:

A = Smooth Inlet/Outlet, C = Threaded Inlet/Outlet
 U = Screen Inlet, MD = Magnetic Drive
 AC = Expose Skelton Motor

CONSTRUCTION & SERVICING:

March "Orbital" Magnetic Drive Pumps eliminate the conventional shaft seals found in most pumps. Hence, there is no rotating seal to wear and allow for leakage of the liquid. In addition to this unique "seal-less" design, the pump is hermetically encapsulated in epoxy. This epoxy encapsulation allows the pumps to be run fully submerged in many liquids. The 1A-MD, 1C-MD, & 1U-MD pumps can be run totally submerged or in open air for complete moisture protection. All pumps can be serviced with a screwdriver. The only moving part other than the motor is the Impeller Assembly, which rotates on a stationary shaft and up against a thrust washer. These are the only parts that can wear, and may need to be replaced. Consult the Repair Parts List for replacements if necessary. For pumping liquids other than water, contact the factory.

OPERATION:

Pumps are not self priming and will not produce a suction lift and must be installed with a positive flooded suction. These pumps rely on the liquid being pumped to lubricate the Impeller Assembly spinning on the stationary shaft and, therefore, are not intended for dry running.

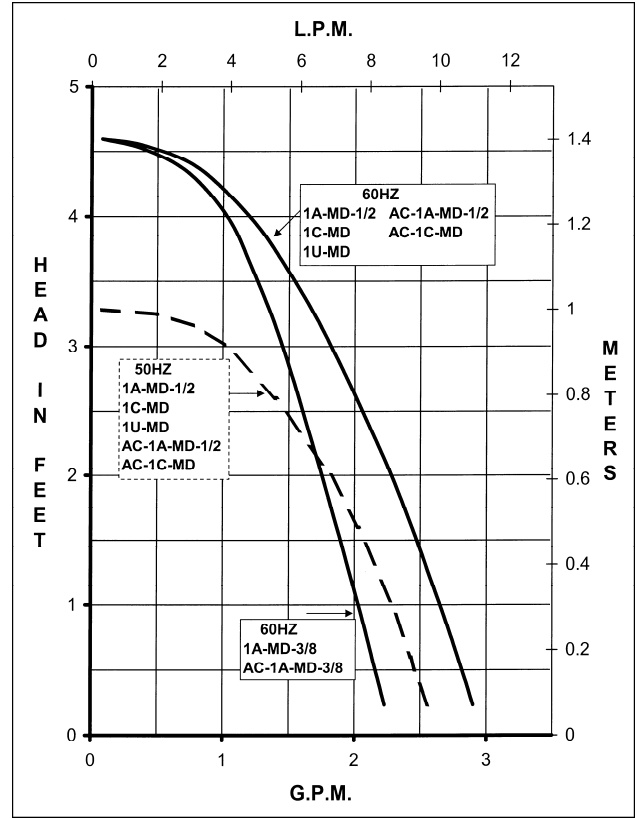

SPECIFICATIONS			1A-MD-3/8	1A-MD-1/2	1C-MD	1U-MD	AC-1A-MD-3/8	AC-1A-MD-1/2	AC-1C-MD
Max Flow	50Hz	lpm	8.7	9	9	9	8.7	9	9
	60Hz	gpm	2.3	3.0	3.0	3.0	2.3	3.0	3.0
Max Head	50Hz	m	1	1	1	1	1	1	1
	60Hz	ft (psi)	4.6 (2.0)	4.6 (2.0)	4.6 (2.0)	4.6 (2.0)	4.6 (2.0)	4.6 (2.0)	4.6 (2.0)
Inlet			3/8" OD	1/2" OD	1/4" MPT	Screen	3/8" OD	1/2" OD	1/4" MPT
Outlet			3/8" OD	1/2" OD	1/4" MPT	1/4" MPT	3/8" OD	1/2" OD	1/4" MPT
Max Internal Pressure		psi	50	50	50	50	50	50	50
		bar	3.4	3.4	3.4	3.4	3.4	3.4	3.4
Max Liquid Temperature		°F	190 open air 160 sub	190 open air 160 sub	190 open air 160 sub	190 open air 160 sub	190 open air	190 open air	190 open air
		°C	87 open air 71 sub	87 open air 71 sub	87 open air 71 sub	87 open air 71 sub	87 open air	87 open air	87 open air
Packed Weight		kg/lbs	1.13/2.5	1.13/2.5	1.13/2.5	1.13/2.5	1.04/2.3	1.04/2.3	1.04/2.3
Motor Type			TE/SUB 115 or 230	TE/SUB 115 or 230	TE/SUB 115 or 230	TE/SUB 115 or 230	Skelton 115 or 230	Skelton 115 or 230	Skelton 115 or 230
Phase			1	1	1	1	1	1	1
50Hz	Volts		115 230	115 230	115 230	115 230	230	230	230
	Watts		19 19	19 19	19 19	19 19	19	19	19
	Amps		0.45 0.23	0.45 0.23	0.45 0.23	0.45 0.23	0.23	0.23	0.23
	Kw		0.003 0.003	0.003 0.003	0.003 0.003	0.003 0.003	0.003	0.003	0.003
	Rpm		2650 2650	2650 2650	2650 2650	2650 2650	2650	2650	2650
60Hz	Volts		115 230	115 230	115 230	115 230	115 230	115 230	115 230
	Watts		19 19	19 19	19 19	19 19	19 19	19 19	19 19
	Amps		0.45 0.23	0.45 0.23	0.45 0.23	0.45 0.23	0.45 0.23	0.45 0.23	0.45 0.23
	Hp		1/200 1/200	1/200 1/200	1/200 1/200	1/200 1/200	1/200 1/200	1/200 1/200	1/200 1/200
	Rpm		3200 3200	3200 3200	3200 3200	3200 3200	3200 3200	3200 3200	3200 3200
Electrical Connection			Cord	Cord	Cord	Cord	Loose Leads	Loose Leads	Loose Leads
Overall Pump Dimensions (Inches)	Height		3.17	3.17	3.17	3.17	3.06	3.06	3.06
	Width		3.75	3.75	3.75	3.75	3.60	3.60	3.60
	Length		4.44	4.44	4.44	3.83	4.38	4.38	4.38
Overall Pump Dimensions (cm)	Height		8.0	8.0	8.0	8.0	7.7	7.7	7.7
	Width		9.5	9.5	9.5	9.5	9.1	9.1	9.1
	Length		11.2	11.2	11.2	9.7	11.1	11.1	11.1

ELECTRICAL:

Models are 115 Volt or 230 Volt, 60Hz or 50/60Hz, 1 phase A.C. All cord sets are U.L. LISTED 18/3 wire SJT plastic. The motors (#16) are C.S.A. approved under File NO. 40072. The models 1A-MD, 1C-MD and 1U-MD are U.L. Recognized under the U.L. component program. U.L. Recognition On Pumps Is For Water Only.

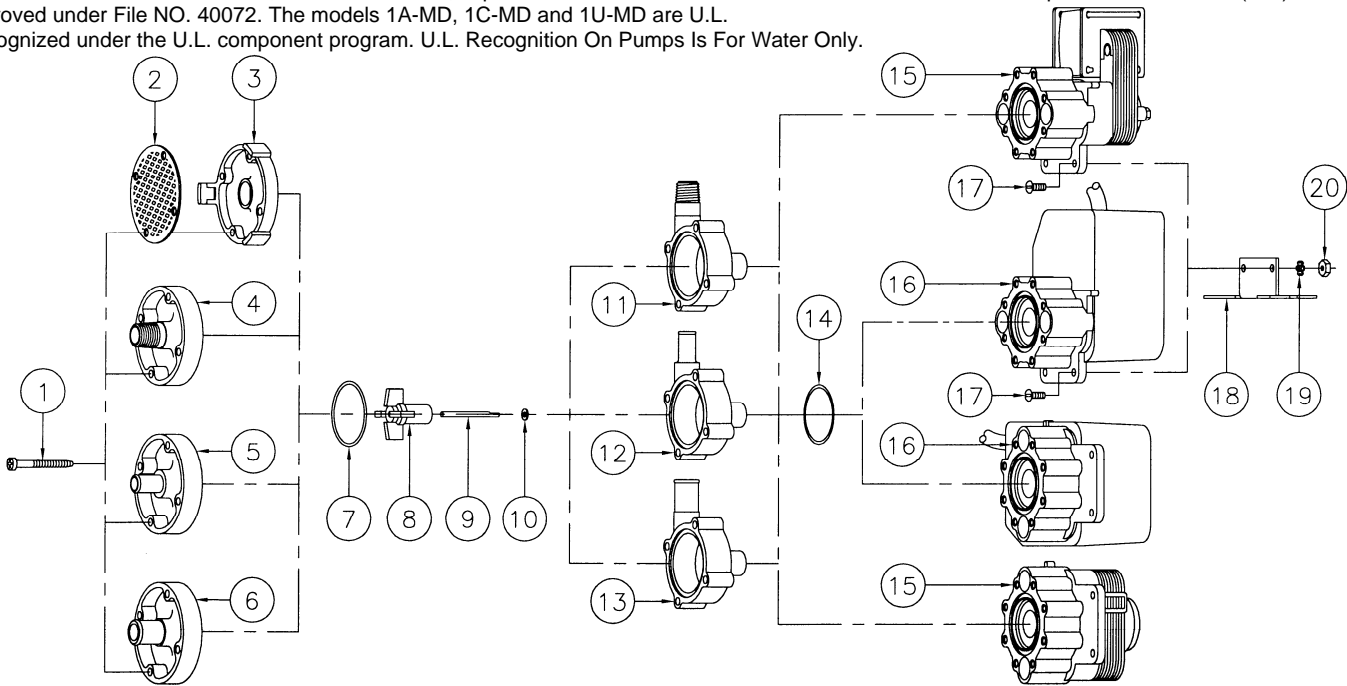

REPAIR PARTS LIST

ITEM	DESCRIPTION	MATERIAL	QTY	PART #	1A-MD-3/8	1A-MD-1/2	1C-MD	1U-MD	AC-1A-MD-3/8	AC-1A-MD-1/2	AC-1C-MD
1	Screw, Self Tapping	Stainless Steel	4	0115-0062-1000	S	S	S	S	S	S	S
2	Inlet Screen	Delrin	1	0115-0012-1000	O	O	O	S			
3	Cover	Cyclac	1	0115-0016-1000	O	O	O	S			
4	Cover (1/4" MPT Inlet)	Polypropylene	1	0115-0058-1000	O	O	S	O	O	O	S
5	Cover (3/8" O.D. Inlet)	Polypropylene	1	0115-0075-1000	S	O	O	O	S	O	O
6	Cover (1/2" O.D. Inlet)	Polypropylene	1	0115-0060-1000	O	S	O	O	O	S	O
7	"O" Ring (Cover) 1/16"CS x 1-5/16"ID x 1-7/16"OD	Buna N	1	0115-0018-1000	S	S	S	S	S	S	S
8	Impeller Assembly	Nylon/Ceramic Mag.	1	0115-0008-0100	S	S	S	S	S	S	S
9	Shaft	316 Stainless	1	0115-0032-1000	S	S	S	S	S	S	S
10	Thrust Washer	Carbon/Teflon	1	0115-0033-1000	S	S	S	S	S	S	S
11	Rear Housing (1/4" MPT Outlet)	Polypropylene	1	0115-0057-1000	O	O	S	S	O	O	S
12	Rear Housing (3/8" O.D. Outlet)	Polypropylene	1	0115-0074-1000	S	O	O	O	S	O	O
13	Rear Housing (1/2" O.D. Outlet)	Polypropylene	1	0115-0059-1000	O	S	O	O	O	S	O
14	"O" Ring (Bracket) 1/16"CS x 1-3/16"ID x 1-5/16"OD	Buna N	1	0115-0017-1000	S	S	S	S			
15A	Air Cooled Assembly (115 Volt 60Hz)		1	0858-0009-0100					S	S	S
15B	Air Cooled Assembly (230 Volt 50/60Hz)		1	0858-0013-0100					S	S	S
16A	Motor/Bracket/Cord/Drive Mag. Assembly (115 Volt 50/60Hz)		1	0115-0006-0100	S	S	S	S			
16B	Motor/Bracket/Cord/Drive Mag. Assembly (230 Volt 50/60Hz)		1	0115-0006-0200	S	S	S	S			
17	Screw	Stainless Steel	2	0455-0038-1000	O	O	O	O	O	O	O
18	Base	Stainless Steel	1	0115-0081-1000	O	O	O	O	O	O	O
19	Lockwasher	Stainless Steel	2	0455-0037-1000	O	O	O	O	O	O	O
20	Nut	Steel	2	0455-0043-1000	O	O	O	O	O	O	O

NOTE: Contact Factory for other materials and/or parts not listed.

Legend: S = Standard, O = Optional

MATERIALS IN CONTACT WITH SOLUTION:

Polypropylene, Nylon, Buna N, 316 Stainless Steel, Ceramic Magnet, and Carbon/Teflon washer. When epoxy pumps are submerged the following additional materials are in contact Epoxy, Noryl®, Cyclac, Delrin, and SJT cord.

NOTES:

All specifications & data are based on pumping water and are intended for use as a guideline only. Ratings & dimensions may vary depending on the current motor being used.

LIMITED WARRANTY:

March pumps are guaranteed only against defects in workmanship or materials for a period of one year from date of manufacture pumping water. On all other solutions, contact the factory for application assistance. March Pump Application Worksheet 0750-0130-1000 is available for additional warranty information.