

# OSCILLATING PUMPS

## OSCILLATING PUMPS

Flojet oscillating pumps are designed for general consumer, commercial and industrial applications. All models are self-priming double insulated and built to draw low amps for cool operation and can run dry for extended periods of time without damage.

### SPECIFICATIONS

#### Technical Data:

Type of Pump	ET508-LP	ET508-HP	ET500	ET200
Temperature	Max. 160° F/71° C	Max. 160° F/71° C	Max. 160° F/71° C	Max. 176° F/80° C
Open Flow Rate	.32 GPM/73 LPH	.40 GPM/90 LPH	.18 GPM/40 LPH	3.8 GPH/240 cc/min.
Maximum Pressure	38 PSI/2.6 Bar	55 PSI/3.8 Bar	230 PSI/16 Bar	20 PSI/1.4 Bar
Self-Priming (up to)	6 (inHg)	6 (inHg)	2.6 (inHg)	1.3 (inHg)
Standard Voltage	115V/60Hz and 230V/50Hz, other voltages available upon request.			
Power Consumption (nominal)	37 Watts	46 Watts	53 Watts	18.5 Watts
Insulation Class	F (155° C)	F (155° C)	F (155° C)	H (180° C)
Elastomers	EPDM, Viton and Buna			
Piston and Spring	Stainless Steel for all models			
Filtering	4/1000 Mesh			
Approvals	U.L. and CSA Recognized, CE Certified*			

\* Approvals vary within the Product Line. Contact a Flojet Representative for specific model listings, recognitions and certifications.

Includes internal diode (except ET200 which requires an external diode).

#### Standard Model Numbering System

##### ET508

ET508-ABC		
A Model Type	B Voltage	C Port - Elastomer
1=LP Low Pressure	2=115/60Hz	1=Std. Port - EPDM
2=HP High Pressure	4=230/50Hz	2=Std. Port - Viton
3=HF High Flow		3=Threaded Port 1/8" F - EPDM
		4=Threaded Port 1/8" F - Viton

##### ET500

ET500-ABC		
A Model Type	B Voltage	C Port - Elastomer
2=HP High Pressure	2=115/60Hz	3=Threaded Port 1/8" F - EPDM
	4=230/50Hz	4=Threaded Port 1/8" F - Viton

##### ET 200

ET200-ABC		
A Model Type	B Voltage	C Port - Elastomer
0=LF Low Flow	2=115/60Hz	1=Std. Port - EPDM
	4=230/50Hz	

#### Mounting Brackets

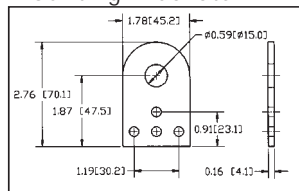

Straight Bracket - Part No. 20900000  
• For ET508, ET500

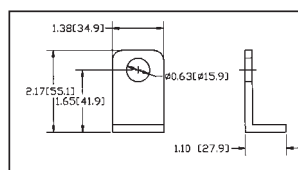

'L' Shaped Bracket - Part No. 20890000  
• For ET508, ET500

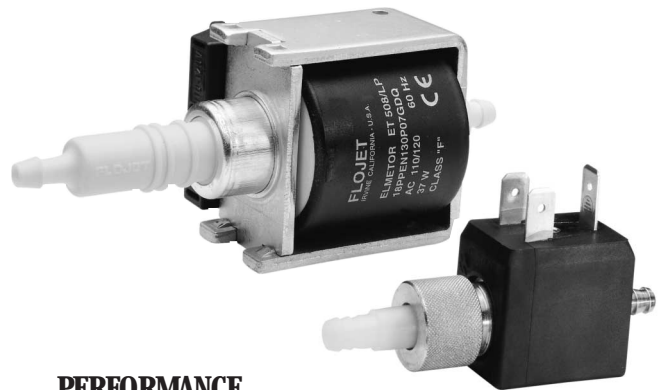

### PERFORMANCE

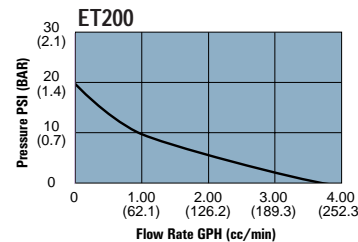
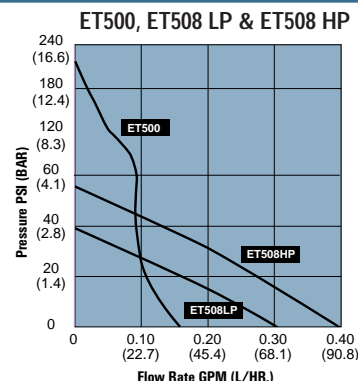

### DIMENSIONS inches (mm) & MOUNTING BRACKETS

#### 508/500 Series

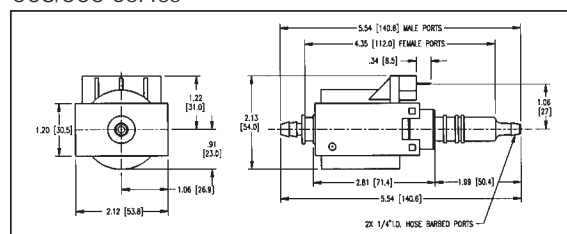

#### 200 Series

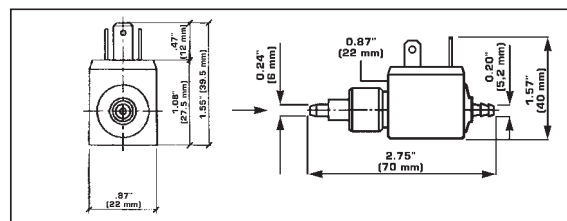

**IndustrialZONE.com™**  
Your Portal to the Industrial World

IndustrialZone  
P.O. Box 667306  
Houston, Texas 77266  
United States

(713)-395-1508  
Fax: (713) 893-6924  
support@industrialzone.com  
[www.industrialzone.com](http://www.industrialzone.com)

# FLOJET

## ET 508 Series Industrial Oscillating Pump

### PRODUCT DATA

Pump Design .....	Oscillating (Piston) Pump
Wetted Parts .....	Spring .....302 Stainless Steel
.....Piston .....	.....430 Stainless Steel
.....Check Valves .....	.....EPDM or Viton
.....O-Ring Seal .....	.....Teflon
.....Retainer .....	.....B rass
.....Housing .....	.....Minlon
Ports .....	.....1/4" Barb ports
Net Weight .....	.....1.2 Pounds (0.55 kg)
Insulation .....	.....Class "F"
Recognition .....	.....U.L., CE

### STANDARD MODEL NUMBERING SYSTEM

ET508 - X X X		
Model Type	Voltage	Port & Elastomer
1 = LP	1 = 100/50 Hz	1 = Std. Port - EPDM
2 = HP	2 = 115/60 Hz	2 = Std. Port - Viton
3 = HF	3 = 240/60 Hz	3 = 90° Port - EPDM
	4 = 230/50 Hz	4 = 90° Port - Viton

ET 508 Series Industrial Oscillating Pump

### PERFORMANCE SPECIFICATIONS

#### PUMP

Coil Motor .....	.....115 VAC, 230 VAC	
	Max Amps 115 VAC.. 0.48 @ 0 PSI (0.0 bar)	
Liquid Temperature Max .....	.....160°F (72°C)	
Dry Vac .....	.....7 ft (6.0 inches Hg)	
Wet Vac.....	.....12.5 ft (11.0 inches Hg)	
Flow Rates*.....HP .....	.....0.37 GPM @ 0 PSI (0.0 bar) Nominal	
	LP .....	.....0.32 GPM @ 0 PSI (0.0 bar) Nominal
Bypass .....	HP .....	.....55 PSI (3.8 bar) Nominal
	LP .....	.....38 PSI (2.6 bar) Nominal

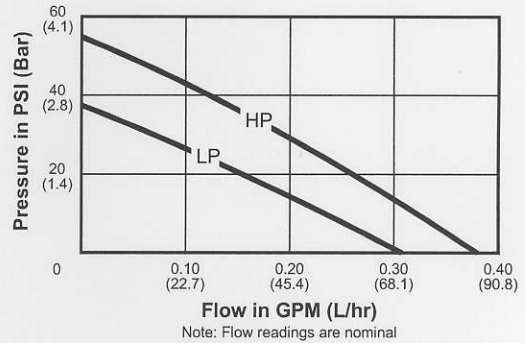

\*Open flow rate may vary +/- 15% depending on installation

### DIMENSIONAL PUMP DRAWING

Dimensional tolerances +/- 0.06 inches.  
Consult factory if precise details are required.

Dimensions:  
Inches (millimeters)

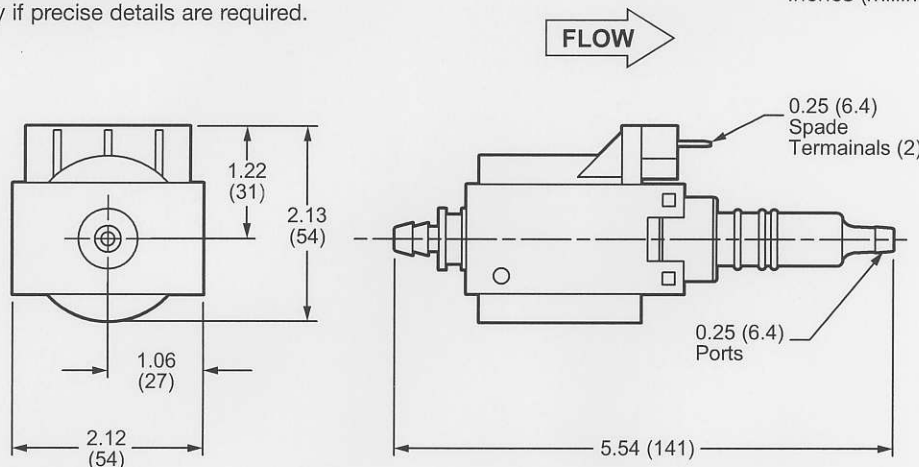

## GENERAL SAFETY INFORMATION

Protect yourself and others by observing all safety information. Shut off power and drain pressure from system prior to service.

To reduce the risk of electric shock, DO NOT try to disassemble pump. No serviceable parts inside.

## DESCRIPTION

Flojet Oscillating Pumps are designed for general commercial and industrial applications. These pumps are constructed from a selection of materials for handling a broad range of chemicals, BUT ARE NOT SUBMERSIBLE. Different elastomers can be selected to match the specific pumping application for different liquids and temperatures. Typical applications include; Carpet Cleaning Equipment, Welding Machines, Air Conditioning Systems, Boiler Cleaning, Water Cleaning Equipment, Medical-Chemical Units, Vending Machines (For Soft Drinks), Espresso Coffee Machines, General Transfer, Primer, Fertilizer Dispensing and Sewage Treatment.

**Operation** - Reference Diagram Below The AC input power is rectified by a single diode connected to the solenoid coil (2). When the positive half wave of current passes through the diode to energize the coil, an electromagnetic field pulls the piston (3) and compresses the piston spring (1). This piston movement creates a vacuum in the chamber (5) and opens the inner check valve (4), which allows fluid to flow from the inlet port into the chamber (5). A diode blocks the negative half wave of the input current. Then the electromagnetic field dies, and the piston spring pushes the piston in the opposite direction. The inner check valve closes, and the chamber (5) is pressurized. The pressurized chamber (5) cracks the outer check valve (6) and the fluid is forced out through the outlet port (7). This cycle repeats 60 times per second for a 60 Hz AC input power, and 50 times per second for 50 Hz AC input power.

Pump discharge line must be open, to allow primeability and avoid airlock. When discharge valve is closed the pump will run in total by pass.

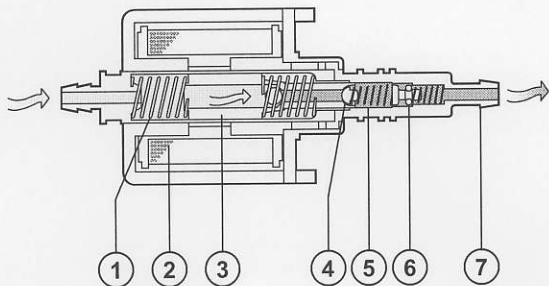

## MOUNTING

There are several ways to mount the FLOJET ET508 Series pumps. These pumps should be mounted in a dry and adequately ventilated area. Preferably mounted at or below the fluid source in any position; however, the pump can be mounted up to 7ft. above the fluid source. THIS NOT A SUBMERSIBLE PUMP. High viscosity fluids and hose length will limit priming distance and capability.

The pump is normally supported at each end with the mounting lands marked "A" below.

To diminish noise and vibration the pump is often mounted using some form of flexible standoff. Typically, rubber sheet stock or similar material is punched with holes "D" to accept the oscillating pump mounting lands "A". the ridges on each side of the mounting lands "A". the ridges on each side of the mounting lands keep the rubber standoff in position. Holes "B" are used to fasten the sheet stock to the rigid frame of the equipment.

The second method and usually the least expensive involves fabricating two posts with "U" shaped saddled as shown below "C". The posts are positioned to accept the oscillating pumps' mounting lands marked "A" and are usually integrated into the motor enclosure. If the enclosure is injection molded, the saddles may be designed as part of the enclosure. The pump can be secured to the saddles by means of a clip that fits across the top of each saddle, (not shown), or a strap can be used to hold the pump in the saddle. The pump can also be secured using a clam shell arrangement by fabricating a saddle in both the top and the bottom enclosure. When the top and bottom enclosure are closed together, the pump is captured in between the top and the bottom saddle which acts like a "clam shell".

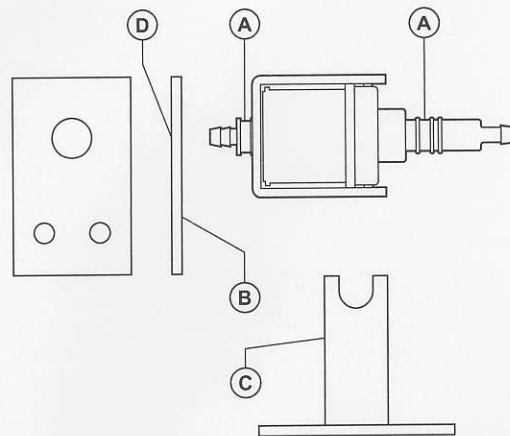

Mounting brackets are examples of mounting configuration, NOT supplied by FLOJET

## PLUMBING

Use a flexible 1/4" hose to avoid excess stress on pump ports. DO NOT crimp or kink tubing. All tubing should be the same size as the pump.

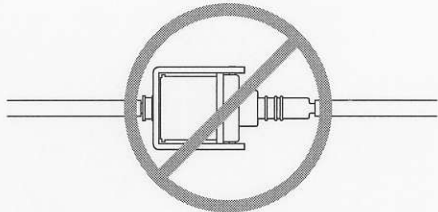

RIGID PIPE

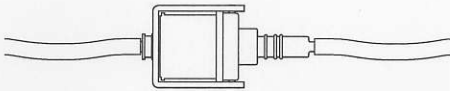

FLEXIBLE HOSE

It is recommended that a 100 mesh strainer or filter be installed in the tank or pump inlet line to keep foreign particles out of the system.

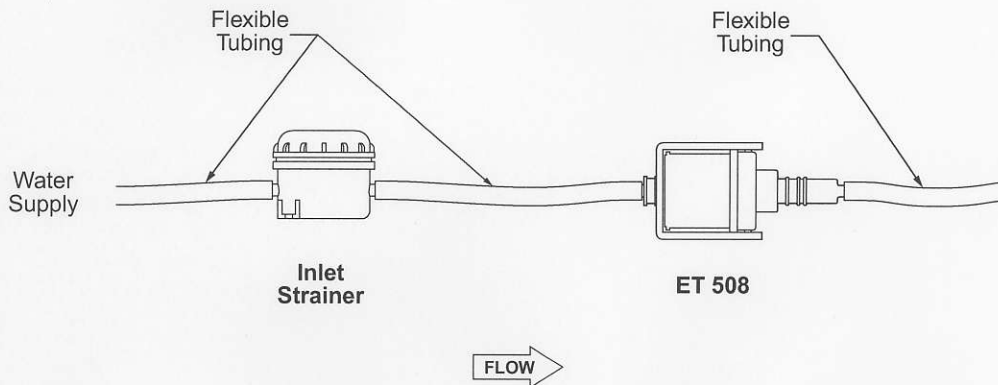

**WARNING**



## ELECTRICAL

**RISK OF AN ELECTRICAL SHOCK!** When wiring an electrically driven pump, follow all electrical and safety codes, as well as the most recent National Electrical Code (NEC) and the Occupational Safety and Health Act (OSHA).

To reduce risk of fire or shock hazard, do not expose this pump to rain or moisture.

Make certain the power source conforms to the pump voltage. Be sure all power is disconnected before installation. All wiring should be performed by qualified electrician.

Both 115 & 230 VAC pumps, common or neutral can be attached to either spade connector. The ET508 Oscillating Pump is double insulated and grounding the pump is not necessary.

## SPRAY TIPS

In spraying applications, the pressure generated by the pump is dependent upon the size of the spray nozzle. While pumps are capable of pumping against a dead head or dry running (clogged spray tip), operating pumps in these modes is not recommended for extended periods.



**WARNING**



**DO NOT USE PUMP IN A FLAMMABLE ENVIRONMENT. DO NOT USE TO PUMP FLAMMABLE OR EXPLOSIVE FLUIDS SUCH AS GASOLINE, FUEL OIL, KEROSENE, ETC.**

## TROUBLESHOOTING CHART

symptom	Possible Cause(s)	Corrective Action
Pump will not prime or retain prime after operating	1. Air leak in suction line 2. Suction lift too high 3. Hose kinked 4. Hose fitting not tight on head	1. Repair or replace 2. Lower pump 3. Straighten hose 4. Tighten hose
Pump runs but no fluid	1. Faulty suction piping 2. Suction lift too high 3. Discharge height too great 4., Clogged inlet 5. Pump too far from liquid	1. Repair or replace 2. Lower pump 3. Lower the height 4. Clean or replace 5. Relocate
Pump runs too hot	1. Voltage incorrect 2. Excessive discharge pressure  3. Liquid too viscous 4. Plugged or kinked discharge 5. Insufficient air flow on pump 6. High by-pass pressure	1. Check voltage 2. Reduce pressure or eliminate restrictions 3. Reduce viscosity of liquid 4. Examine & repair 5. Be sure ample fresh air is available 6. Change nozzle size
Flow rate is low	1. Piping or hose is damaged 2. Clogged nozzles 3. Voltage incorrect	1. Clean or replace 2. Clear obstruction or replace 3. Check voltage
Pump will not run	1. No electricity 2. Pump has open circuit 3. Excessive back Pressure	1. Determine proper electrical hook-up 2. Replace pump 3. Release pressure

## CONVERSION TABLE

TO CONVERT	TO	MULTIPLY BY
Gallons, U.S.	Liters	3.785
Liters	Gallons, U.S.	0.264
Pounds/Sq. Inch	Bar	0.069
Bar	Pounds/Sq. Inch	14.5
Fahrenheit	Celsius	(°F-32) .556
Celsius	Fahrenheit	(°C X 1.8) + 32

## WARRANTY

FLOJET warrants this product to be free of defects in material and/or workmanship for a period of one year after purchase by the customer from FLOJET. During this one year warranty period, FLOJET will at its option, at no charge to the customer, repair or replace this product if found defective, with a new or reconditioned product, but not to include costs of removal or installation. No product will be accepted for return without a return material authorization number. All return goods must be shipped with transportation charges prepaid. This is only a summary of our Limited Warranty. For a copy of our complete warranty, please request Form No. 100-101.

## RETURN PROCEDURE

Prior to returning any product to FLOJET, call customer service for an authorization number. This number must be written on the outside of the shipping package. Place a note inside the package with an explanation regarding the reason for return as well as the authorization number. Include your name, address and phone number.

## Flojet



**ITT Industries**  
*Engineered for life*

U.S.A.  
Flojet  
20 Icon  
Foothill Ranch, CA 92610-3000  
Tel: (949) 859-4945  
Fax: (949) 859-1153

UNITED KINGDOM  
Jabsco/Flojet  
Bingley Road, Hoddesdon  
Hertfordshire EN11 OBU  
Tel: +44 (0) 1992 450145  
Fax: +44 (0) 1992 467132

CANADA  
Fluid Products Canada  
55 Royal Road  
Guelph, Ontario N1H 1T1  
Tel: (519) 821-1900  
Fax: (519) 821-2569

JAPAN  
NHK Jabsco Company Ltd.  
3-21-10, Shin-Yokohama  
Kohoku-Ku, Yokohama, 222  
Tel: 045-475-8906  
Fax: 045-475-8908

GERMANY  
Jabsco GmbH  
Oststrasse 28  
22844 Norderstedt  
Tel: +49-40-53 53 73-0  
Fax: +49-40-53 53 73-11

**Industrial ZONE.com™**  
Your Portal to the Industrial World

**IndustrialZone**  
P.O. Box 667306  
Houston, Texas 77266  
United States

(713)-395-1508  
Fax: (713) 893-6924  
support@industrialzone.com  
[www.industrialzone.com](http://www.industrialzone.com)